

Mediklin

 Healthcare

You Specify We Create



MAKING HEALTHCARE EASIER & MORE ACCESSIBLE WITH INNOVATIVE SOLUTIONS

AS A LEADING MANUFACTURER OF SURGICAL PRODUCTS, MEDIKLIN OFFERS AN EXTENSIVE ARRAY OF SURGICAL DRAPES AND ANCILLARY PRODUCTS. WE AIM TO PROVIDE THE RIGHT SOLUTION & PROTECTION TO PATIENTS AND CLINICIANS IN ANY SITUATION WHETHER IT BE SKIN FLORA MIGRATION OR SURGICAL PROCEDURES.

OUR RANGE OF SURGICAL DRAPES IS CAREFULLY DESIGNED TO MATCH ALL INDUSTRY TESTING CRITERIA SEAMLESSLY. OUR SURGICAL DRAPES AND GOWNS PROVIDE OPTIONS OF AAMI LEVEL 1, 2, 3 AND 4.



SURGICAL SOLUTIONS

MEDIKLIN'S SURGICAL GOWNS, DRAPES & PACKS ARE **CAREFULLY DESIGNED** TO OFFER EXCELLENCE, EXEMPLARY RESISTANCE AND COMFORT WITH INNOVATIVE FABRIC TECHNOLOGY. OUR EXTENSIVE RANGE OF SURGICAL GOWNS AND DRAPES ARE DIVIDED INTO FOUR PERFORMANCE LEVELS, TO PROVIDE A WIDE CHOICE OF PROTECTION WITHOUT COMPROMISE.

HIGH PERFORMANCE STANDARDS -

OUR PRODUCTS GO THROUGH RIGOROUS QUALITY CONTROL AND MEET INTERNATIONAL STANDARDS

- ◆ FOR A LONG DURATION, HIGH FLUID-INTENSIVE PROCEDURES
- ◆ FOR COMPLEX, HIGH-RISK SPECIALIZED SURGERIES

ADVANCED PROTECTION THROUGH TOP QUALITY PRODUCTS

(SSMMS / SMMS / SMS / SPUNLESS)

- ◆ SSMMS / SMMS / SMS ARE THE COMBINATIONS OF "SPUNBOND + MELTBLOWN + SPUNBOND NONWOVENS" WHERE IN :
 - THE SPUNBOND OUTER LAYERS COMPRISE OF EXCEPTIONAL STRENGTH AND ARE HIGHLY DURABLE
 - THE MELTBLOWN MIDDLE LAYERS ACTS AS AN EFFECTIVE BARRIER TO BACTERIA AND LIQUIDS
 - THE MATERIAL IS DESIGNED WITH LOW LINT LEVELS AND DECREASES THE RISK OF CONTAMINATION IN THE OR
- ◆ SPUNLESS IS THE COMBINATION OF "POLYESTER + VISCOSE NONWOVENS"

KEY REQUIREMENTS FOR INFECTION BARRIER ARE:

- ◆ BARRIER TO BACTERIA FOR INFECTION PREVENTION
- ◆ BARRIER TO FLUID AND BLOOD PENETRATION

AAMI LEVELS

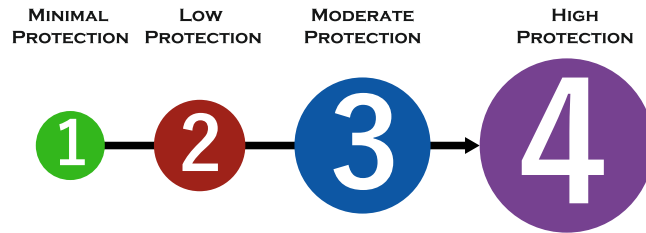

SURGICAL DRAPES

DRAPES INCLUDE SEVERAL FEATURES TO FACILITATE THE SURGEONS TO IDENTIFY DIFFERENT ZONES TO EFFECTIVELY REDUCE CROSS INFECTION. THEY INCLUDE:

- ◆ ROYAL BLUE COLORED SMS / SMMS / SSMMS DRAPE FABRICS
- ◆ FABRIC ANESTHESIA SCREEN ON SELECT CODES SPACE
- ◆ STANDARDIZED ABSORBENT REINFORCEMENT MATERIAL IN CRITICAL ZONES
- ◆ ADHESION TO THE SKIN OR WOUND EDGES DURING HEAVY RETRACTION AND IRRIGATION

MEDIKLIN MEETS INDUSTRY STANDARDS & REGULATIONS:

FLAMMABILITY STANDARDS :

NON WOVEN MATERIALS TO MATCH THE STANDARDS FOR THE FLAMMABILITY.

LATEX STATEMENT :

SURGICAL DRAPES ARE MANUFACTURED WITHOUT USING NATURAL LATEX RUBBER

VELCRO STYLE HOLDER :

SURGICAL DRAPES FEATURE VELCRO-STYLE LINE HOLDERS/CORD HOLDERS TO PLACE SURGICAL LINES WHICH HELP IN BEING CLEAR OF THE APERTURE. INCORPORATED AS PER INTERNATIONAL STANDARDS.

PREMIUM TAPE & INCISE FILMS :

PREMIUM TAPES AND INCISE FILMS USED ON ALL SURGICAL DRAPES. TAPES ARE DESIGNED TO FLUSH TO THE APERTURE & HELP PREVENT THE AMALGAMATION OF BLOOD AND FLUID BENEATH THE DRAPE.

SURGICAL GOWNS

COST EFFECTIVE SOLUTIONS FOR GOOD PERFORMANCE & PROTECTION

- ◆ FOR LOW FLUID INTENSIVE & MINOR PROCEDURES WITH A SHORT DURATION
- ◆ FOR LONG PROCEDURES THAT INVOLVE HIGHER RISKS

STANDARD SURGICAL GOWNS - AAMI LEVEL 2 & 3 :

- SMS / SMMS / SSMMS FABRIC
- MODERATE TO HIGH RISK SURGERIES

SURGICAL GOWN - AAMI LEVEL 4 :

- "UNIVERSALLY" BREATHABLE FABRIC IMPERVIOUS GOWN
- FOR HIGH RISK DURING SPECIALISED SURGERIES

REINFORCED GOWNS - AAMI LEVEL 2, 3 & 4 :

- REINFORCED SMS / SMMS / SSMMS FABRIC
- FOR HIGHER FLUID INTENSIVE PROCEDURES

PROTECTIVE GOWNS - AAMI LEVEL 1 & 2 :

- SOFT SPUNBOND FABRIC / BILAMINATE FABRIC
- FOR LOW FLUID INTENSIVE MINOR PROCEDURES THAT INVOLVE LOW RISK WITH A SHORT DURATION

CONTENTS

GENERAL SURGERY DRAPES & PACKS

General Surgery Drapes	07
General Surgery Packs	09

SPECIALITY DRAPES

09

MULTI-PROCEDURE DRAPE SHEETS

Bar Drapes	10
Drape Sheet	11
Utility Drapes	11

ORTHOPAEDIC SURGERY DRAPES & PACKS

Extremity Drapes	13
Extremity Packs	14
Knee Arthroscopy Drapes	15
Knee Arthroscopy Packs	15
Shoulders Arthroscopy Drapes	16
Shoulders Arthroscopy Packs	16
Hip Drapes	17
Hip Packs	19

GENERAL ORTHOPAEDIC SURGERY DRAPES & PACKS

General Orthopaedic Surgery Drapes	21
Impervious Split Drapes	21
General Orthopaedic Surgery Packs	22
Protective Surgical Accessories	22

NEUROLOGY & SPINAL DRAPES & PACKS

Neurology Drapes	25
Spinal Drapes & Packs	25

CARDIOVASCULAR & ANGIOGRAPHY DRAPES & PACKS

Cardiovascular Drapes	27
Cardiovascular Packs	28
Angiography Drapes	29

GYNAECOLOGY & OBSTETRICS DRAPES & PACKS

Gynaecology & Obstetrics Drapes	31
Gynaecology & Obstetrics Packs	32

UROLOGY DRAPES & PACKS

Urology Drapes	35
----------------------	----

OPHTHALMOLOGY & ENT DRAPES & PACKS

Ophthalmology & Ent Drapes	37
Ophthalmology & Ent Packs	37

CONTENTS

EQUIPMENT COVERS, ACCESSORIES & STERILIZATION WRAPS

Sterilization Wraps	38
Mayo Stand Cover	39
Back Table Cover	39
Accessories	39
Cautery Bag	39

SURGICAL & PROTECTIVE GOWNS, PROTECTIVE WEARS & PROTECTIVE KITS

Medipro Surgical Gowns, Sterile	41
Medico Surgical Gowns, Sterile	41
Medisure Surgical Reinforced Gowns, Sterile	41
Medisafe Surgical Reinforced Gowns, Sterile	42
Medikool Surgical Extra Protection Gowns, Sterile	42
Proto - Laminated Gown, Sterile	43
Isolation Gown With Knitted Cuff, Sterile	43
Visitor Isolation Gown, Non-Sterile	43
Patient Gown, Non-Sterile	43
Scrub Shirt, Non-Sterile	44
Scrub Pant, Non-Sterile	44
Lab Coat, Non-Sterile	44
Coverall, Non-Sterile	44
Protec Kit, Sterile	45
Surgical Dressing Kit, Sterile	46
Scrub Suit, Non-Sterile	46
Visitor Kit	46
PPE Kit, Non-Sterile	47

PROTECTIVE APPARELS & HYGIENE PRODUCTS

Face Protection	49
Headwear	50
Footwear	51
Apron, Sterile	51
Sheets & Pillow Cover	52
Couch Roll	52

HYGIENE PRODUCTS

Adult Diaper	53
Underpad	53

GENERAL SURGERY DRAPES & PACKS



Mediklin



Healthcare

You Specify We Create





GENERAL SURGERY DRAPES & PACKS

GENERAL SURGERY DRAPES

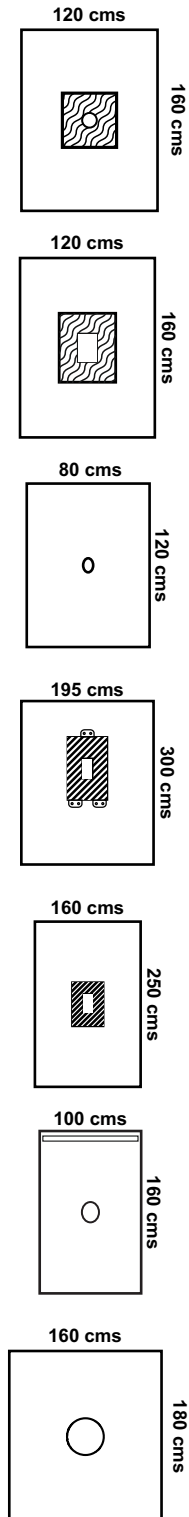

Code	Description	Packaging
2001	Minor Procedure Fenestrated Drape 120 x 160 cms	15

- Circular Fenestration
- Reinforcement
- Positioning Tape

Code	Description	Packaging
2002	Minor Procedure Fenestrated Drape 120 x 160 cms	15

- Rectangular Fenestration
- Reinforcement
- Positioning Tape

Code	Description	Packaging
2003	Aperture Drape 80 x 120 cms	32

- Positioning Tape

Code	Description	Packaging
2004	Universal Fenestrated Drape with incise, 195 x 300 cms	6

- Reinforcement
- Positioning Tape
- Tube Holders

Code	Description	Packaging
2005	Major Drape, 160 x 250 cms	8

- Fenestration 15 x 30 cms
- Reinforcement

Code	Description	Packaging
2006	Epidural Anesthesia Drape 100 x 160cms	20

- Fenestration 8 x 10 cms
- Positioning Tape

Code	Description	Packaging
2008	Circular Fenestrated Drape, 160 x 180cms	15

- Circular Fenestration 16 cms
- Positioning Tape

GENERAL SURGERY DRAPES & PACKS

GENERAL SURGERY DRAPES

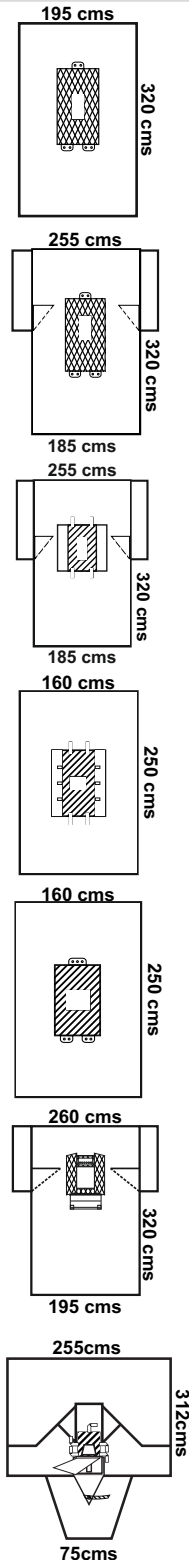

Code	Description	Packaging
2552	Laparotomy Drape 195 x 320 cms	6

- Fenestration 10 x 30 cms
- Reinforcement
- Tube Holders

Code	Description	Packaging
2553	Laparotomy Drape with Incise, 255 x 185 x 320 cms	5

- Fenestration 18 x 33 cms
- Reinforcement
- Armboard Covers
- Tube Holders

Code	Description	Packaging
2554	Laparotomy Drape with Pouches, 255 x 185 x 320 cms	4

- Fenestration 18 x 33 cms
- Reinforcement
- Pouches
- Armboard Covers
- Hook & Loop Line Control

Code	Description	Packaging
2555	Gastro Bariatric Drape with Incise & Pouch, 160 x 250 cms	6

- Fenestration 10 x 28 cms
- Reinforcement
- Pouches
- Tube Holders

Code	Description	Packaging
2581	Laparoscopy Drape with Incise 160 x 250 cms	8

- Transverse Fenestration 29 x 34 cms
- Reinforcement
- Cautery Bag
- Camera Cable Cover

Code	Description	Packaging
2582	Laparoscopic / Cholecystectomy Drape, 260 x 195 x 320 cms	5

- Abdominal Fenestration 28 x 29 cms
- Tube Holders
- Instrument Pouch
- Line Control Flaps
- Armboard Covers
- Positioning Tape

Code	Description	Packaging
2583	Laparoscopy / Pelviscopy Drape 255 x 75 x 312 cms	4

- Abdominal Trapezoidal Fenestration 17 x 23 cms
- Perineal Fenestration 7 x 20cms
- Fluid Collection Pouch
- Leggings
- Positioning Tape
- Tube Holders

GENERAL SURGERY DRAPES & PACKS

GENERAL SURGERY PACKS

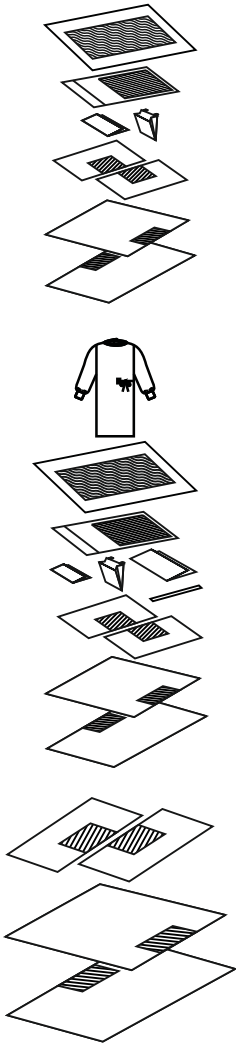

Code	Description	Packaging
2501	Universal Pack I	3

- 1 Sterilisation Wrap
- 1 Tape Strip
- 1 Suture Bag
- 1 Absorbent Towel
- 1 Back Table Cover Reinforced, 112 x 230cms
- 1 Mayo Stand Cover Reinforced, 60 x 140cms
- 1 Top Drape Reinforced, 127 x 275cms
- 1 Bottom Drape Reinforced, 193 x 193cms
- 2 Side Drape Reinforced, 80 x 110cms

Code	Description	Packaging
2502	Universal Pack Plus	3

- 1 Sterilisation Wrap
- 1 Medipro Surgical Gown 'L'
- 1 Medipro Surgical Gown 'XL'
- 5 Absorbent Towel
- 1 Suture Bag
- 1 Tape Strip
- 1 Back Table Cover Reinforced, 112 x 230cms
- 1 Mayo Stand Cover Reinforced, 60 x 140cms
- 6 Utility Drapes, 55 x 65cms
- 2 Side Drape Reinforced, 110 x 160cms
- 1 Bottom Drape Reinforced, 193 x 193cms
- 1 Top Drape Reinforced, 127 x 275cms

Code	Description	Packaging
2531	Universal Set I	4

- 1 Sterilisation Wrap
- 2 Side Drape Reinforced, 80 x 110cms
- 1 Bottom Drape Reinforced, 193 x 193cms
- 1 Top Drape Reinforced, 127 x 275cms

SPECIALITY DRAPES

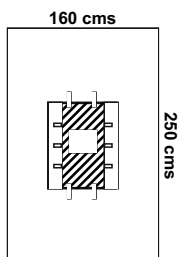

Code	Description	Packaging
2611	Kidney Transplant Drape 160 x 250 cms	8

- Fenestration 25 x 28 cms
- Positioning Tape
- Reinforcement
- Tube Holders
- Pouches



SPECIALITY DRAPES

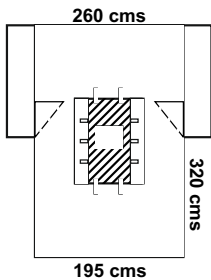
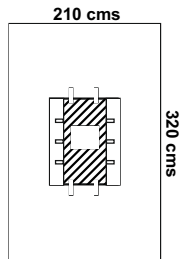

Code	Description	Packaging
2612	Kidney Transplant Drape 210 x 320 cms	5

- Fenestration 25 x 28 cms
- Positioning Tape
- Reinforcement
- Tube Holders
- Pouches

Code	Description	Packaging
2613	Renal Transplant Drape 260 x 195 x 320 cms	4

- Fenestration 25 x 28 cms
- Armboard Covers
- Reinforcement
- Positioning Tape
- Pouches
- Tube Holders

MULTI-PROCEDURE DRAPE SHEETS

BAR DRAPES

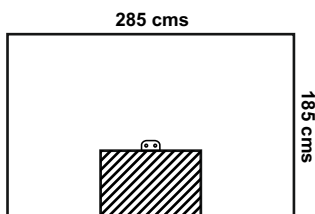
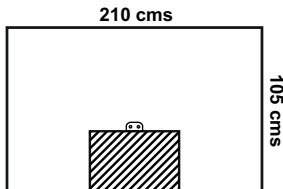
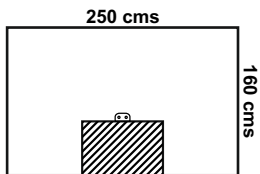

Code	Description	Packaging
2341	Bar Drape 160 x 250 cms	10

- Positioning Tape
- Tube Holder

Code	Description	Packaging
2342	Bar Drape 160 x 250 cms	10

- Reinforcement
- Positioning Tape
- Tube Holder

Code	Description	Packaging
2343	Bar Drape 105 x 210 cms	14

- Reinforcement
- Positioning Tape
- Tube Holders

Code	Description	Packaging
2344	Bar Drape 185 x 285 cms	8

- Reinforcement
- Positioning Tape
- Tube Holders



MULTI-PROCEDURE DRAPE SHEETS

DRAPE SHEET

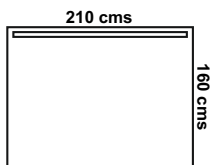
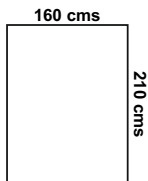
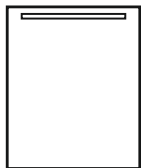
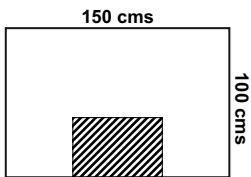
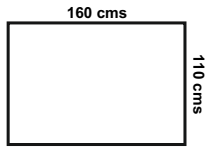

Code	Description	Packaging
2301	Half Drape 110 x 160 cms	22

Code	Description	Packaging
2321	Abdominal Drape, 100 x 150 cms	18

Code	Description	Packaging
2151	Small Drape, 80 x 90 cms	50
2071	Medium Drape, 100 x 160 cms	28
2101	Large Drape, 160 x 195 cms	14

Code	Description	Packaging
2152	Small Drape with Adhesive, 80 x 90 cms	45
2072	Medium Drape with Adhesive, 100 x 160 cms	28
2102	Large Drape with Adhesive, 160 x 195 cms	12

- Positioning Tape

Code	Description	Packaging
2271	Plain Sheet 160 x 210 cms	14

Code	Description	Packaging
2272	Plain Sheet 160 x 210 cms	12

- Positioning Tape

UTILITY DRAPES

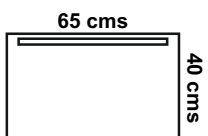

Code	Description	Packaging
2291	Utility Drape 40 x 65 cms	55

- Positioning Tape

ORTHOPAEDIC SURGERY DRAPES & PACKS



Mediklin

 Healthcare

You Specify We Create





ORTHOPAEDIC SURGERY DRAPES & PACKS

EXTREMITY DRAPES

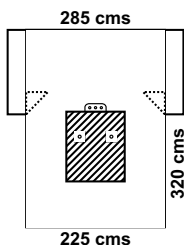
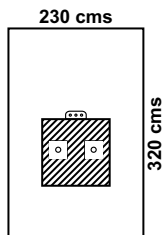
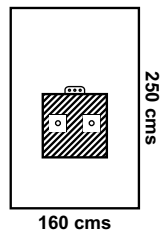
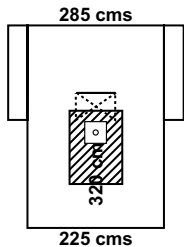
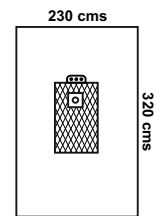
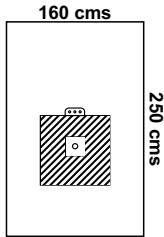

Code	Description	Packaging
3002	Lower Extremity Drape 160 x 250 cms	9

- Reinforcement
- Tube Holders
- Comfortable Circular Fenestrations

Code	Description	Packaging
3003	Lower Extremity Drape 230 x 320 cms	6

- Reinforcement
- Tube Holders
- Comfortable Circular Fenestrations

Code	Description	Packaging
3004	Lower Extremity Drape 285 x 225 x 320 cms	5

- Reinforcement
- Armboard covers
- Tube Holders
- Comfortable Circular Fenestrations

Code	Description	Packaging
3021	Bilateral Knee Drape 160 x 250 cms	9

- Reinforcement
- Tube Holders
- Two Comfortable Circular Fenestrations

Code	Description	Packaging
3022	Bilateral Knee Drape 230 x 320 cms	6

- Reinforcement
- Tube Holders
- Two Comfortable Circular Fenestrations

Code	Description	Packaging
3024	Bilateral Knee Drape 285 x 225 x 320 cms	5

- Reinforcement
- Armboard covers
- Tube Holders
- Two Comfortable Circular Fenestrations



ORTHOPAEDIC SURGERY DRAPES & PACKS

EXTREMITY DRAPES

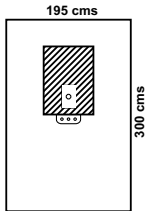

Code	Description	Packaging
3031	Upper Extremity Drape 195 x 300 cms	7

- Reinforcement
- Comfortable Circular Fenestrations
- Tube Holders

EXTREMITY PACKS

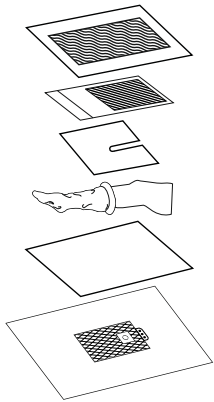

Code	Description	Packaging
3101	Lower Extremity Pack	4

- 1 Sterilisation Wrap
- 3 Tape Strip, 8 x 45cms
- 1 Impervious Split Drape, 140 x 180cms
- 1 Large Drape, 160 x 195cms
- 1 Instrumental Table Cover, 156 x 210cms
- 1 Mayo Stand Cover, 75 x 145cms, Reinforced
- 1 Impervious Stockinette, Medium
- 1 Lower Extremity Drape, 230 x 320cms

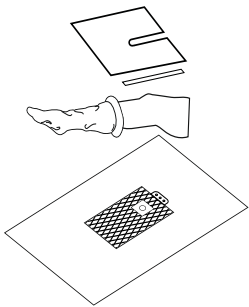

Code	Description	Packaging
3131	Lower Extremity Set	3

- 1 Sterilisation Wrap
- 3 Tape Strip, 8 x 45cms
- 1 Cautery Bag
- 1 Ortho Split Drape, 160 x 180cms
- 1 Impervious Stockinette, MedLarge
- 1 Lower Extremity Drape, 230 x 320cms

ORTHOPAEDIC SURGERY DRAPES & PACKS

KNEE ARTHROSCOPY DRAPES

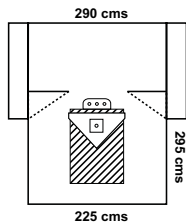
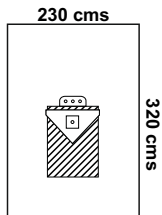
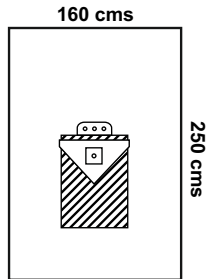

Code	Description	Packaging
3172	Knee Arthroscopy Drape 160 x 250 cms	6

- Attached Fluid Collection Pouch with Suction Port
- Tube Holders
- Comfortable Circular Fenestration

Code	Description	Packaging
3173	Knee Arthroscopy Drape 230 x 320 cms	5

- Attached Fluid Collection Pouch with Suction Port
- Tube Holders
- Comfortable Circular Fenestration

Code	Description	Packaging
3174	Knee Arthroscopy Drape 290 x 225 x 295 cms	4

- Armboard Covers
- Fluid Collection Pouch with Suction Port
- Reinforcement
- Tube Holders

KNEE ARTHROSCOPY PACKS

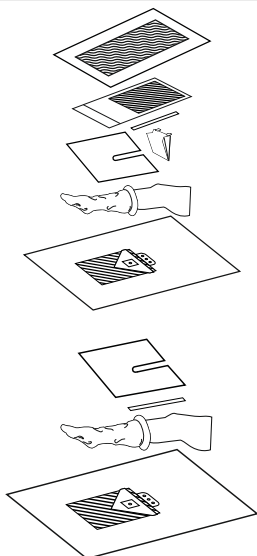

Code	Description	Packaging
3191	Knee Arthroscopy Packs	4

- 1 Sterilisation Wrap
- 4 Tape Strip, 8 x 45cms
- 1 Suture Bag
- 1 - Impervious Stockinette, Medium
- 1 Instrumental Table Cover, 156 x 210cms
- 1 Mayo Stand Cover, 75 x 145cms, Reinforced
- 1 Impervious Split Drape, 140 x 180cms
- 1 Knee Arthroscopy Drape, 230 x 320cms

Code	Description	Packaging
3211	Knee Arthroscopy Set	3

- 1 Sterilisation Wrap
- 4 Tape Strip
- 1 Impervious Split Drape, 140 x 180cms
- 1 Impervious Stockinette, Medium
- 1 Knee Arthroscopy Drape, 230 x 320cms



ORTHOPAEDIC SURGERY DRAPES & PACKS

SHOULDERS ARTHROSCOPY DRAPES

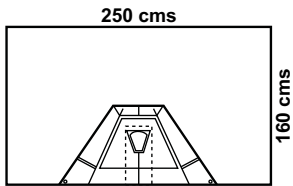
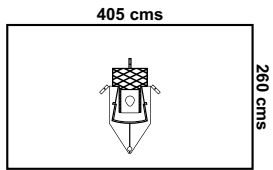
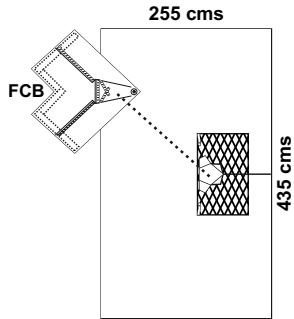

Code	Description	Packaging
3231	Beach Chair Shoulder Drape 255 x 435 cms	4

- Attachable Fluid Collection Pouch With Suction Port
- Hook and Loop Tube and Line Control
- Reinforcement
- Pouch Attachment Zones

Code	Description	Packaging
3232	Beach Chair Shoulder Arthroscopy Drape 260 x 405 cms	4

- Attached Fluid Collection Pouch
- Comfortable Tear Drop Fenestration
- Hook and Loop Tube and Line Control

Code	Description	Packaging
3233	Shoulder Arthroscopy Drape 250 x 160 cms	9

- Attached Fluid Collection Pouch with Suction Ports
- Positioning Tape

SHOULDERS ARTHROSCOPY PACKS

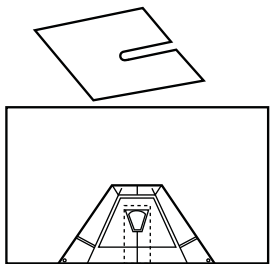

Code	Description	Packaging
3271	Shoulder Arthroscopy Set	3

- 1 Sterilisation Wrap
- 1 Body Split Drape, 235 x 290cms
- 1 Shoulder Arthroscopy Drape, 250 x 160cms



ORTHOPAEDIC SURGERY DRAPES & PACKS

HIP DRAPES

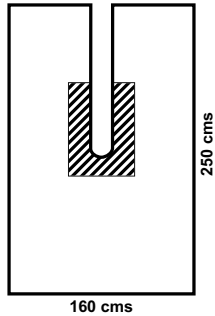

Code	Description	Packaging
3302	Hip U-Drape 160 x 250 cms, Split 15 x 48 cms	9

- Reinforcement
- Positioning Tape

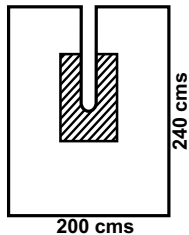

Code	Description	Packaging
3303	Hip U-Drape 200 x 240 cms, Split 15 x 80 cms	6

- Reinforcement
- Positioning Tape

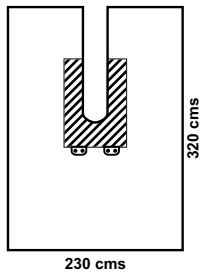

Code	Description	Packaging
3304	Hip U-Drape 230 x 320 cms, Split 15 x 120 cms	6

- Reinforcement
- Tube Holders
- Positioning Tape

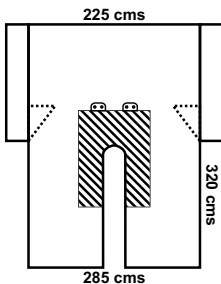

Code	Description	Packaging
3305	Hip U-Drape 285 x 225 x 320cm, Split 15 x 120 cms	5

- Reinforcement
- Tube Holders
- Positioning Tape
- Armboard Covers

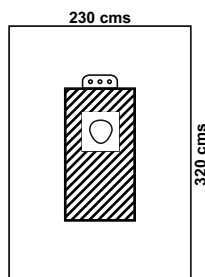

Code	Description	Packaging
3307	Hip Drape 230 x 320 cms	6

- Reinforcement
- Tube Holders
- Comfortable Teardrop Fenestration



ORTHOPAEDIC SURGERY DRAPES & PACKS

HIP DRAPES

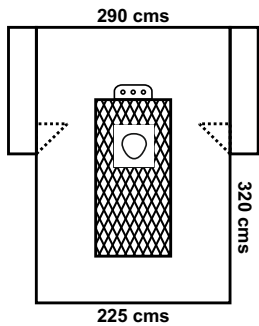

Code	Description	Packaging
3308	Hip Drape 290 x 225 x 320 cms	5

- Reinforcement
- Comfortable Teardrop Fenestration
- Tube Holders
- Armboard Covers

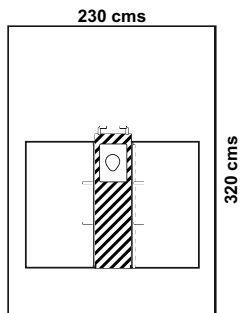

Code	Description	Packaging
3309	Hip Drape with Pockets, 230 x 320 cms	4

- Reinforcement
- Comfortable Teardrop Fenestration
- Tube Holders
- Pockets on Both Sides

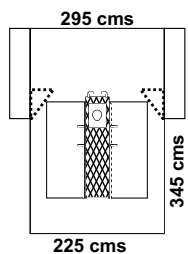

Code	Description	Packaging
3310	Hip Drape with Pockets, 295 x 225 x 345 cms	3

- Pockets on Both Sides
- Armboard Covers
- Reinforcement
- Tube Holders

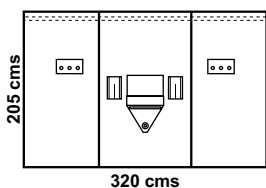

Code	Description	Packaging
3312	Vertical Isolation Drape 205 x 320 cms	8

- Adhesive Incise Area
- Tube Holders
- Attachable Instrument Pouch
- Fluid Collection Pouch With Suction Port
- With Tape Strip for Attachment to Horizontal Rod



ORTHOPAEDIC SURGERY DRAPES & PACKS

HIP PACKS

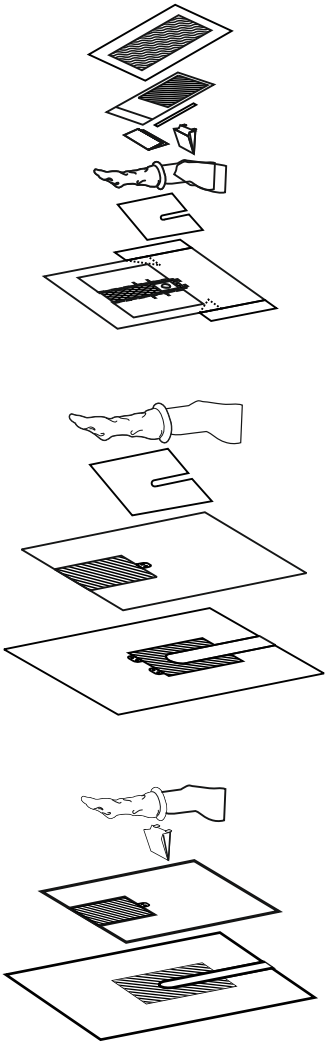

Code	Description	Packaging
3331	Hip Pack (THR)	3

- 1 Sterilisation Wrap
- 1 Suture Bag
- 4 Tape Strip
- 2 Absorbent Towel
- 1 Hip Drape Reinforced with Pockets, 295 x 225 x 345cms
- 1 Back Table Cover Reinforced, 112 x 230cms
- 1 Mayo Stand Cover Reinforced, 60 x 140cms
- 1 Impervious Stockinette, Large
- 1 Large Impervious Split Drape, 150 x 200cms

Code	Description	Packaging
3351	Hip Set (THR) I	2

- 1 Sterilisation Wrap
- 3 Tape Strip
- 1 Impervious Stockinette, Medium
- 1 Bar Drape Reinforced, 160 x 250cms
- 1 Large Impervious Split Drape, 150 x 200cms
- 1 Hip U-Drape Reinforced, 230 x 320cms

Code	Description	Packaging
3352	Hip Set (THR) II	4

- 1 Sterilisation Wrap
- 2 Tape Strip
- 1 Cautery Bag
- 1 Impervious Stockinette, Medium
- 1 Bar Drape Reinforced, 160 x 250cms
- 1 Hip U-Drape Reinforced, 200 x 240cms



GENERAL ORTHOPAEDIC SURGERY DRAPES & PACKS



Mediklin
 **Healthcare**
You Specify We Create





GENERAL ORTHOPAEDIC SURGERY DRAPES & PACKS

GENERAL ORTHOPAEDIC SURGERY DRAPES

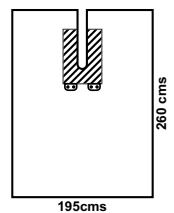
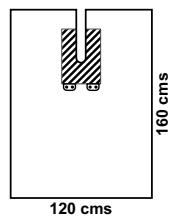
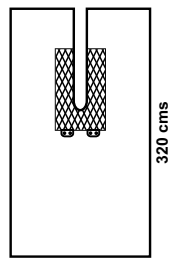
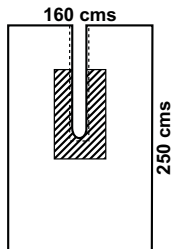

Code	Description	Packaging
3402	U-Drape 160 x 250 cms, Split 10 x 80 cms	9

- Reinforcement
- Positioning Tape

Code	Description	Packaging
3404	U-Drape 180 x 320 cms, Split 10 x 102 cms	6

- Reinforcement
- Positioning Tape
- Tube Holders

Code	Description	Packaging
3421	U-Drape Arm 120 x 160 cms, Split 8 x 45 cms	16

- Reinforcement
- Positioning Tape
- Tube Holders

Code	Description	Packaging
3422	U-Drape Arm 195 x 260 cms, Split 8 x 65 cms	6

- Reinforcement
- Positioning Tape
- Tube Holders

IMPERVIOUS SPLIT DRAPES

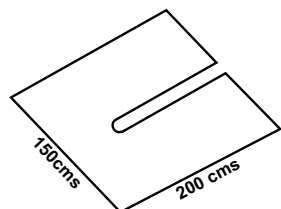
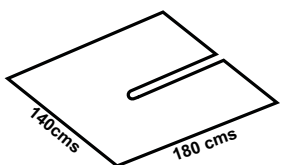

Code	Description	Packaging
3501	Impervious Split Drape 140 x 180 cms	36

- Split
- Positioning Tape

Code	Description	Packaging
3502	Large Impervious Split Drape 150 x 200 cms	28

- Large Split
- Positioning Tape



GENERAL ORTHOPAEDIC SURGERY DRAPES & PACKS

IMPERVIOUS SPLIT DRAPES

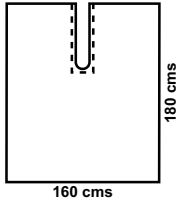

Code	Description	Packaging
3503	Ortho Split Drape 160 x 180 cms	14

- Split
- Positioning Tape

GENERAL ORTHOPAEDIC SURGERY PACKS

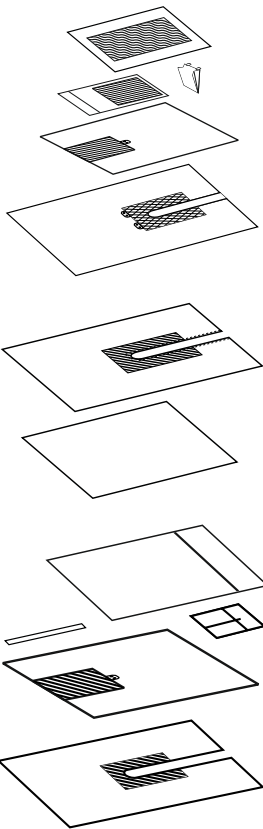

Code	Description	Packaging
3451	U Bar Pack	4

- 1 Sterilisation Wrap
- 1 Suture Bag
- 1 Bar Drape, 105 x 210cms
- 1 Back Table Cover , 112 x 230cms
- 1 Mayo Stand Cover 60 x 140cms
- 1 U Drape, 180 x 320cms

Code	Description	Packaging
3471	Ortho Set I	14

- 1 Sterilisation Wrap
- 1 Medium Drape, 100 x 160cms
- 1 U Drape, 160 x 175cms

Code	Description	Packaging
3472	Ortho Pack III	8

- 1 Sterilisation Wrap
- 2 Tape Strip
- 1 Caution Bag
- 1 Impervious Legging, Large
- 1 Bar Drape Reinforced, 100 x 160cms
- 1 Leg U-Drape Reinforced, 160 x 175cms

PROTECTIVE SURGICAL ACCESSORIES

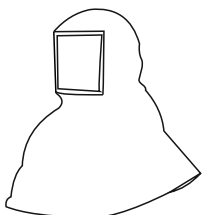

Helmet Cover

Code	Description	Packaging
3521	Helmet Cover Dlx	30



GENERAL ORTHOPAEDIC SURGERY DRAPES & PACKS

PROTECTIVE SURGICAL ACCESSORIES

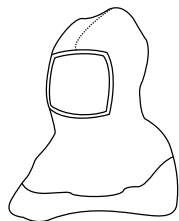

Code	Description	Packaging
3522	Helmet Cover	30

Code	Description	Packaging
3550	Cling Drape, 15 x 600cms	70



Code	Description	Packaging
3531	Impervious Stockinette, Large	14
3532	Impervious Stockinette, Medium	17
3534	Impervious Legging, Large	18



NEUROLOGY & SPINAL DRAPES & PACKS



Mediklin

 Healthcare

You Specify We Create





NEUROLOGY & SPINAL DRAPES & PACKS

NEUROLOGY DRAPES

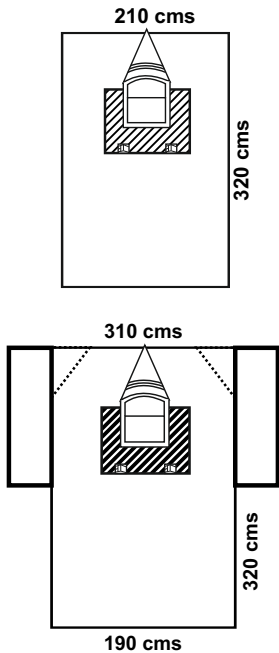

Code	Description	Packaging
4001	Craniotomy Drape, 160 x 250cms	10

- Reinforcement
- Fluid Collection Pouch with Suction Port

Code	Description	Packaging
4003	Craniotomy Drape, 210 x 320cms	5

- Reinforcement
- Oval Fenestration
- Fluid Collection Pouch with Suction Port

Code	Description	Packaging
4004	Craniotomy Drape, 310 x 190 x 320cms	4

- Reinforcement
- Oval Fenestration
- Fluid Collection Pouch with Suction Port
- Clear Gusseted Anesthesia Panels

Code	Description	Packaging
4005	Shunt Drape, 120 x 200cms	20

SPINAL DRAPES & PACKS

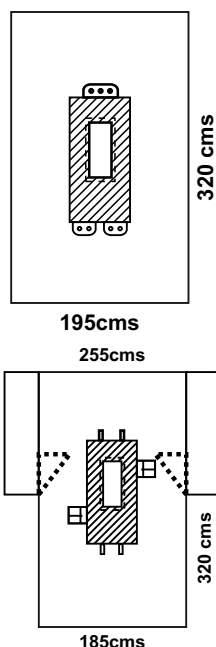

Code	Description	Packaging
4022	Lamino Spinal Drape with Incise, 160 x 300cms	8

- Reinforcement

Code	Description	Packaging
4023	Universal Spinal Drape with Incise, 195 x 320cms	6

- Reinforcement

Code	Description	Packaging
4024	Laminectomy Spinal Drape with Incise, 255 x 185 x 320cms	4

- Reinforcement
- Armboard Covers
- Hook-n-loop Tube Holders
- Clear Instrument Pouch

**CARDIOVASCULAR &
ANGIOGRAPHY
DRAPES & PACKS**



Mediklin

 **Healthcare**

You Specify We Create





CARDIOVASCULAR DRAPES & PACKS

CARDIOVASCULAR DRAPES

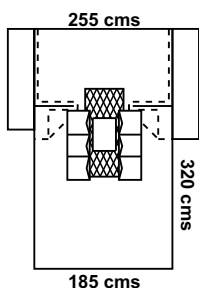
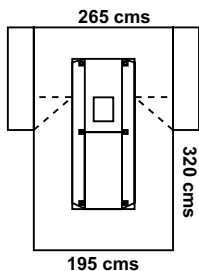
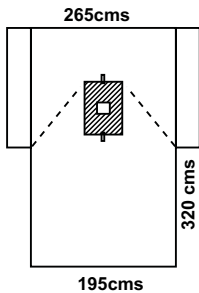
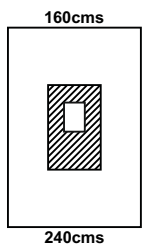
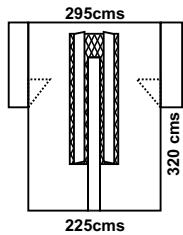

Code	Description	Packaging
4101	CV Split Drape 295 x 225 x 320 cms	3

- Armboard Covers
- Reinforcement
- Vertical Reinforcement Pockets
- Positioning Tapes

Code	Description	Packaging
4201	Cardiovascular Chest Sheet with Incise, 160 x 240cms	8

- Reinforcement

Code	Description	Packaging
4202	Breast / Chest Drape with Incise, 265 x 195 x 320cms	4

- Reinforcement
- Armboard Covers

Code	Description	Packaging
4203	Breast / Chest Drape, 255 x 185 x 320cms	4

- Reinforcement
- Armboard Covers
- Instrument Bag

Code	Description	Packaging
4204	CV Incise Drape, 265 x 195 x 320cms	3

- Reinforcement
- Chest Adhesive Incise Area
- Armboard Covers
- Leg Adhesive Incise Area
- Longitudinal Flaps

Code	Description	Packaging
4205	CV Chest Incise Drape, 265 x 195 x 365cms	3

- Reinforcement
- Pouches
- Tube Holders



CARDIOVASCULAR DRAPES & PACKS

CARDIOVASCULAR DRAPES

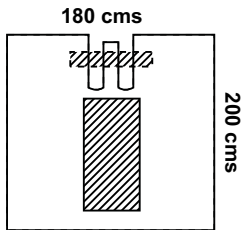
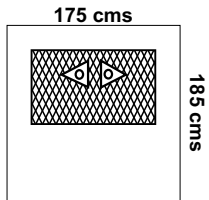

Code	Description	Packaging
4206	Central Venous Catheter Drape with Incise, 175 x 185cms	8

- Diameter Circular Fenestrations
- Reinforcement
- Equilateral Triangles With Incise

Code	Description	Packaging
4301	Bilateral Underleg / Perineal Drape, 180 x 200cms	8

- Reinforcement
- Positioning Tape

CARDIOVASCULAR PACKS

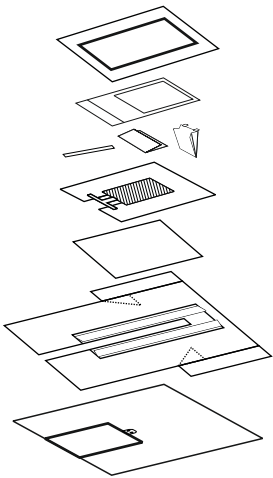

Code	Description	Packaging
4121	Cardiac Pack I	3

- 1 Sterilisation Wrap
- 2 Absorbent Towel
- 1 Suture Bag
- 2 Tape Strip 8 x 45cms
- 2 Foot Covers
- 1 Small Drape, 80 x 90cms
- 1 Instrument Table Cover, 156 x 230 cms
- 1 Mayo Stand Cover Reinforced, 65 x 145cms
- 1 Perineal Split Drape Reinforced, 180 x 200cms
- 1 CV Split Drape Reinforced, 295 x 240cms
- 1 Bar Drape Reinforced, 195 x 240cms



ANGIOGRAPHY DRAPES & PACKS

ANGIOGRAPHY DRAPES

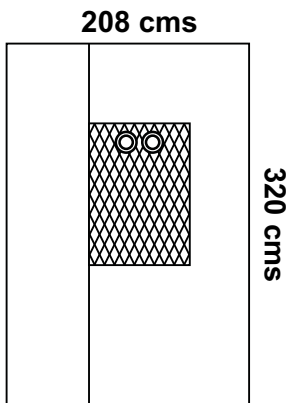

Code	Description	Packaging
4402	Femoral Angiography Drape, 160 x 250cms	10

- Reinforcement
- Two Adhesive Circular Fenestrations

Code	Description	Packaging
4403	Femoral Angiography Drape with Single Window, 208 x 320cms	7

- Reinforcement
- Two Adhesive Circular Fenestrations

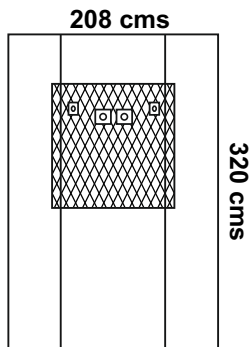

Code	Description	Packaging
4441	Radial Angiography Drape, 160 x 200cms	8

- Reinforcement
- Two Round Femoral Fenestrations
- Two Oval Radial Fenestrations

Code	Description	Packaging
4443	Radial Femoral Angiography Drape, 208 x 320cms	6

- Reinforcement
- Two Round Femoral Fenestrations
- Two Oval Radial Fenestrations

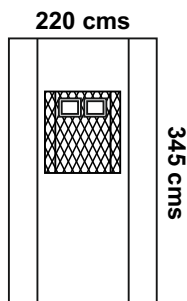

Code	Description	Packaging
4461	Pace Maker Drape, 220 x 345cms	6

- Reinforcement
- Clear Incise
- Bilateral Pockets

**GYNAECOLOGY &
OBSTETRICS
DRAPES & PACKS**



Mediklin

 **Healthcare**

You Specify We Create





GYNAECOLOGY & OBSTETRICS DRAPES & PACKS

GYNAECOLOGY & OBSTETRICS DRAPES

Code	Description	Packaging
4501	Caesarean Drape, 160 x 250 cms	6

- Adhesive Incise Area
- Tube Holders
- Fluid Collection Pouch with Suction Port

Code	Description	Packaging
4502	Caesarean Drape, 195 x 300 cms	5

- Adhesive Incise Area
- Tube Holders
- Fluid Collection Pouch with Suction Port
- Fenestration 20 x 30 cms

Code	Description	Packaging
4503	Caesarean Drape, 255 x 185 x 320 cms	4

- Adhesive Incise Area
- Tube Holders
- Fluid Collection Pouch with Suction Port
- Armboard Covers

Code	Description	Packaging
4504	Caesarean Drape, 255 x 185 x 320 cms	4

- Adhesive Incise Area
- Tube Holders
- Fluid Collection Pouch with Suction Port
- Armboard Covers

Code	Description	Packaging
4601	Under Buttock Drape, 100 x 120cms	34

Code	Description	Packaging
4602	Under Buttock Drape with Fluid Collection Pouch, 38 x 110cms	28

- Absorbent Pad

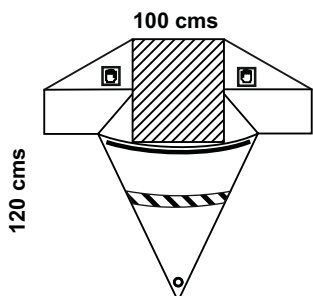
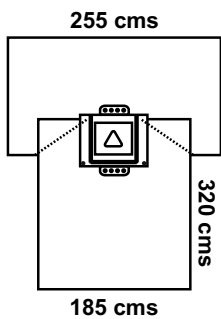
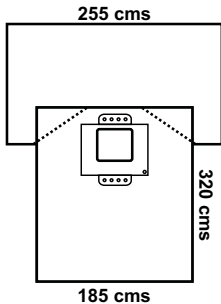
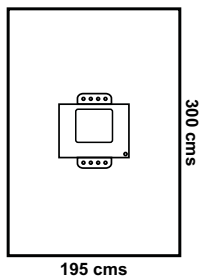



GYNAECOLOGY & OBSTETRICS DRAPES & PACKS

GYNAECOLOGY & OBSTETRICS DRAPES

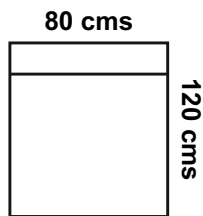
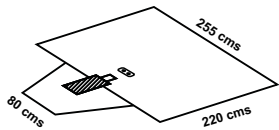
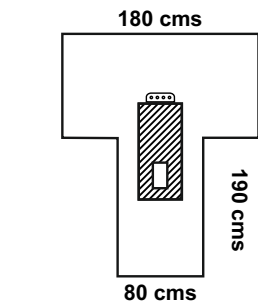
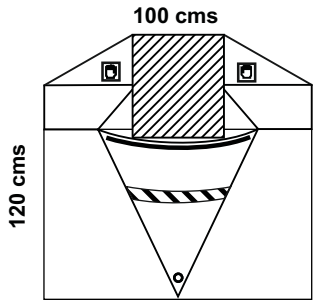

Code	Description	Packaging
4603	Under Buttock Drape with Fluid Collection Pouch, 100 x 120cms	22

- Absorbent Pad

Code	Description	Packaging
4701	Gynaec Drape, 160 x 200cms	12

Code	Description	Packaging
4702	Lithotomy 'T' Drape, 155 x 80 x 190cms	12

- Perineal Fenestration
- Tube Holders
- Positioning Tape
- Reinforcement

Code	Description	Packaging
4703	Lithotomy Drape with attached Leggings, 255 x 80 x 220cms	6

- Perineal Fenestration
- Tube Holders
- Positioning Tape
- Reinforcement

Code	Description	Packaging
4751	Leggings with cuff, 80 x 120cms	14

GYNAECOLOGY & OBSTETRICS PACKS

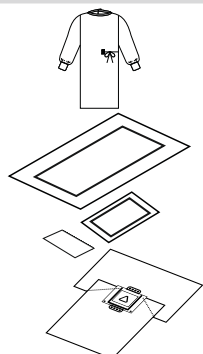

Code	Description	Packaging
4521	Caesarean Pack	2

- 1 Sterilisation Wrap
- 1 Surgeons Gown 'M'
- 1 Surgeons Gown 'L'
- 2 Surgeons Gown 'XL'
- 1 C-Section Drape with Fluid Collection Pouch, 255 x 185 x 32 cms, Full Adhesive Incise Area, Tube Holders
- 1 Back Table Cover Deluxe - 140 x 200cms
- 1 Absorbent Towel 30 x 40cms
- 1 Baby Blanket Reinforced, 80 x 130cms



GYNAECOLOGY & OBSTETRICS DRAPES & PACKS

GYNAECOLOGY & OBSTETRICS PACKS

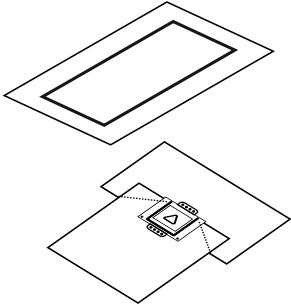

Code	Description	Packaging
4541	Caesarean Set	6

- 1 Sterilisation Wrap
- 1 Baby Blanket Reinforced, 80 x 130cms
- 1 C-Section Drape with Fluid Collection Pouch, 255 x 185 x 320 cms, Full Adhesive Incise Area, Tube Holders

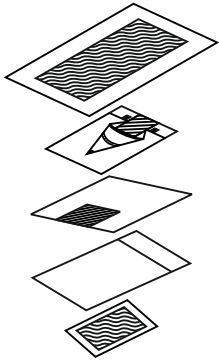

Code	Description	Packaging
4651	Delivery Pack	4

- 1 Sterilisation Wrap
- 1 Back Table Cover Reinforced, 110 x 150cms
- 2 Leggings with cuff, 80 x 120cms
- 1 Abdominal Drape Reinforced, 100 x 150cms
- 1 Baby Blanket Reinforced, 80 x 130cms
- 1 Under Buttock Drape with Fluid Collection Pouch, 100 x 120cms

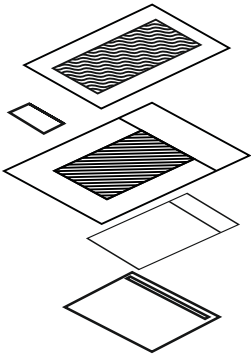

Code	Description	Packaging
4731	Lithotomy Pack I	5

- 1 Sterilisation Wrap
- 1 Back Table Cover Reinforced, 112 x 230cms
- 1 Absorbent Towel
- 1 Under Buttock Drape Reinforced, 100 x 120cms
- 2 Leggings with cuff, 80 x 120cms
- 1 Half Drape, 110 x 160cms

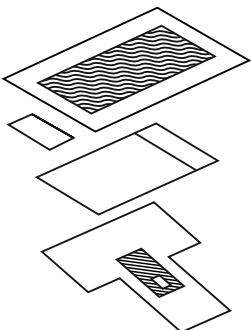

Code	Description	Packaging
4732	Lithotomy Pack II	4

- 1 Sterilisation Wrap
- 1 Back Table Cover Reinforced, 112 x 230cms
- 1 Absorbent Towel
- 1 Utility Drapes, 55 x 65cms
- 2 Leggings with cuff, 80 x 120cms
- 1 Lithotomy 'T' Drape Reinforced, 155 x 80 x 190cms

UROLOGY DRAPES & PACKS



Mediklin

 Healthcare

You Specify We Create





UROLOGY DRAPES & PACKS

UROLOGY DRAPES

Code	Description	Packaging
5001	Cystoscopy Drape 150 x 160cms	7

- Attached Leggings
- Screen
- Tube Holder
- Positioning Tape

Code	Description	Packaging
5002	Cystoscopy T-Drape 150 x 80 x 220 cms	10

- Fabric Reinforcement
- Screen
- Tube Holder
- Positioning Tape

Code	Description	Packaging
5003	Cystoscopy Drape 255 x 80 x 220 cms	4

- Attached Leggings
- Screen
- Tube Holder
- Positioning Tape
- Fabric Reinforcement & Poly Reinforcement

Code	Description	Packaging
5021	T.U.R. Drape 150 x 160 cms	7

- Attached Leggings
- Fluid Collection Pouch

Code	Description	Packaging
5022	T.U.R. Drape 175 x 290 x 170 cms	4

- Attached Leggings
- Finger Cot
- Fluid Collection Pouch with Screen, Suction Port and Tie

Code	Description	Packaging
5041	PCNL Drape with Incise, 160 x 250cms	8

- Fabric Reinforcement
- Tube Holder
- Incise Tape
- Instrument Bags

Code	Description	Packaging
5042	PCNL Drape 160 x 250cms	7

- Fabric Reinforcement
- Tube Holder
- Incise Tape
- Instrument Bags
- Fluid Collection Pouch

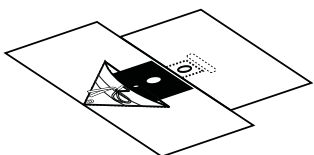
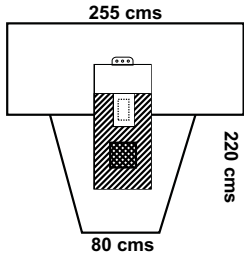

175 cms x 290cms x 170 cms

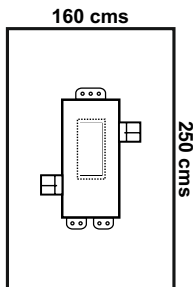

160 cms

250 cms

OPHTHALMOLOGY & ENT DRAPES & PACKS



Mediklin

 Healthcare

You Specify We Create





OPHTHALMOLOGY & ENT DRAPES & PACKS

OPHTHALMOLOGY & ENT DRAPES

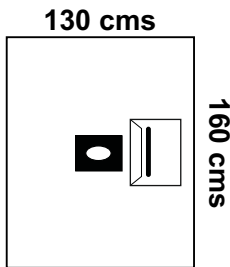

Code	Description	Packaging
5202	Eye Drape 130 x 160 cms	20

- With One Single Fluid Collection Pouch
- Applicable for Both Left & Right Eye
- Oval Fenestration 8 cms with Aperture Incise 10 x 12 cms

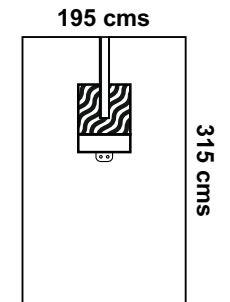

Code	Description	Packaging
5201	Eye Drape, 60 x 60cms	170

Code	Description	Packaging
5241	ENT Split Drape, 195 x 315cms	7

- Reinforcement
- Positioning Tape
- Tube Holder

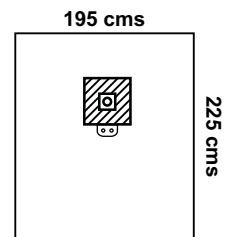

Code	Description	Packaging
5242	ENT Drape, 195 x 225cms	9

- Reinforcement
- Positioning Tape
- Tube Holder

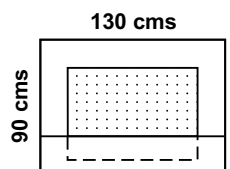

Code	Description	Packaging
5243	Head Drape Turban, 90 x 130cms	12

- Positioning Tape

OPHTHALMOLOGY ENT PACKS

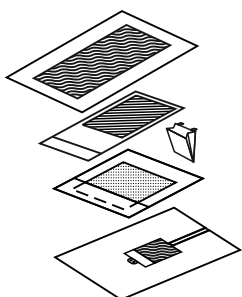

Code	Description	Packaging
5261	ENT Pack I	3

- 1 Sterilisation Wrap 100 x 100cms
- 1 Mayo Stand Cover 75 x 145cms, Reinforced
- 1 Back Table Cover Deluxe Reinforced, 140 x 200cms
- 1 Head Drape Turban, 90 x 130cms
- 1 Suture Bag
- 1 ENT Split Drape Reinforced, 195 x 320cms

EQUIPMENT COVERS, ACCESSORIES & STERILIZATION WRAPS



Mediklin
 **Healthcare**
 You Specify We Create

STERILIZATION WRAPS

Code	Description	Packaging
5721	Sterilization Wrap Regular 160 x 160cms	120
5722	Sterilization Wrap Regular 120 x 120cms	250
5723	Sterilization Wrap Regular 100 x 100cms	250
5724	Sterilization Wrap Regular 90 x 90cms	300
5725	Sterilization Wrap Regular 75 x 75cms	450
5726	Sterilization Wrap Regular 60 x 60cms	650
5727	Sterilization Wrap Regular 50 x 50cms	800
5741	Sterilization Wrap Heavy Duty 160 x 160cms	120
5742	Sterilization Wrap Heavy Duty 120 x 120cms	250
5743	Sterilization Wrap Heavy Duty 100 x 100cms	250
5744	Sterilization Wrap Heavy Duty 90 x 90cms	300
5745	Sterilization Wrap Heavy Duty 75 x 75cms	400
5746	Sterilization Wrap Heavy Duty 60 x 60cms	600
5747	Sterilization Wrap Heavy Duty 50 x 50cms	800

- Low-Lint SMS Fabric
- Steam and EO Compatible
- Compatible with Low Temperature Gas Plasma Sterilisation



EQUIPMENT COVERS & ACCESSORIES

MAYO STAND COVER

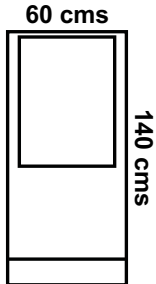

Code	Description	Packaging
5321	Mayo Stand Cover, 60 x 140 cms	42
5322	Mayo Stand Cover Reinforced, 60 x 140 cms	35
5323	Mayo Stand Cover Reinforced, 75 x 145 cms	26

BACK TABLE COVER

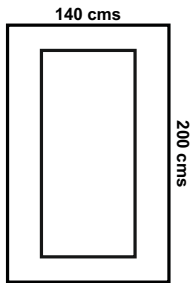

Code	Description	Packaging
5341	Back Table Cover Reinforced, 112 x 150cms	26
5342	Back Table Cover Reinforced, 112 x 230cms	20
5344	Back Table Cover Reinforced, 140 x 200cms	17
5345	Back Table Cover Reinforced, 152 x 230cms	12
5347	Instrument Trolley Cover, 156 x 230cms	14

ACCESSORIES

Code	Description	Packaging
5371	C Arm Cover 2pcs, 28" x 34"	62
5381	Camera Cover, 9" x 80"	34

Code	Description	Packaging
5301	Set Up Cover, 110 x 160cms	26

CAUTERY BAG

Code	Description	Packaging
5501	Cautery Bag, 16" x 15"	285

Code	Description	Packaging
5502	Instrument Bag, 30 x 32cms	285

**SURGICAL &
PROTECTIVE GOWNS,
PROTECTIVE WEARS,
PROTECTIVE KITS**



Mediklin



You Specify We Create





SURGICAL GOWNS, STERILE

MEDIPRO SURGICAL GOWNS, STERILE

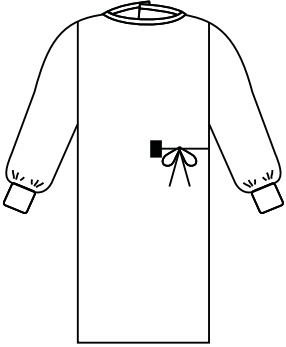

Code	Description	Packaging
1001	Medipro Surgical Gowns Medium	12
1002	Medipro Surgical Gowns Large	12
1003	Medipro Surgical Gowns X-Large	12
1004	Medipro Surgical Gowns X-Large, X-Long	10
1005	Medipro Surgical Gowns XX-Large	10

- SSMMS / SMS Fabric
- Low Linting Fabric
- Sterile Gown packaged with 2 Towels
- Set-In-Sleeves
- Book Fold
- Adjustable Hook & Loop Neckline
- Colour-Coded Neck Binding
- Overlapping Back
- AAMI Level 3 Gown

MEDICO SURGICAL GOWNS, STERILE

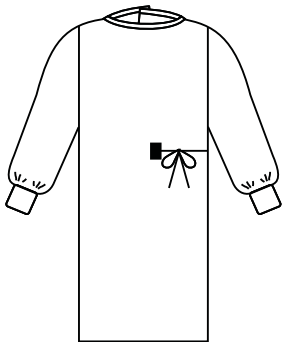

Code	Description	Packaging
1101	Medico Surgical Gowns Medium	15
1102	Medico Surgical Gowns Large	15
1103	Medico Surgical Gowns X-Large	15
1104	Medico Surgical Gowns X-Large, X-Long	12
1105	Medico Surgical Gowns XX-Large	12

- SMMS / SMS Fabric
- Low Linting Fabric
- Colour-Coded Neck Binding
- Book Fold
- Sterile Gown packaged with 1 / 2 Towels
- AAMI Level 3 Gown

MEDISURE SURGICAL REINFORCED GOWNS, STERILE

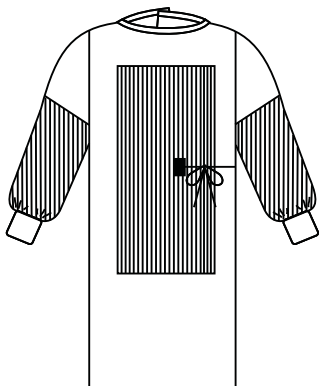

Code	Description	Packaging
1031	Medisure- Reinforced Surgical Gowns Medium	12
1032	Medisure- Reinforced Surgical Gowns Large	12
1033	Medisure- Reinforced Surgical Gowns X-Large	12
1034	Medisure- Reinforced Surgical Gowns X-Large, X-Long	10
1035	Medisure- Reinforced Surgical Gowns XX-Large	10

- SMMS / SMS Fabric
- Book Fold
- Sterile Gown packaged with 2 Towels
- Overlapping Back
- Low Linting Fabric
- Colour-Coded Neck Binding
- Reinforced Chest and Sleeves
- Adjustable Hook & Loop Neckline
- AAMI Level 4 Gown



SURGICAL GOWNS, STERILE

MEDISAFE SURGICAL REINFORCED GOWNS, STERILE

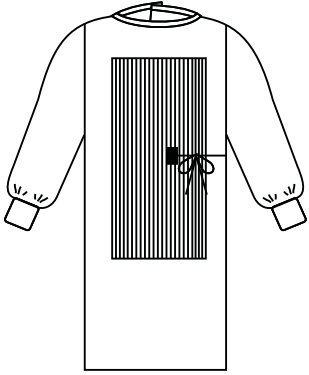

Code	Description	Packaging
1061	Medisafe Reinforced Surgical Gowns Medium	12
1062	Medisafe Reinforced Surgical Gowns Large	12
1063	Medisafe Reinforced Surgical Gowns X-Large	12
1064	Medisafe Reinforced Surgical Gowns X-Large, X-Long	10
1065	Medisafe Reinforced Surgical Gowns XX-Large	10

- SMMS / SMS Fabric
- Book Fold
- Sterile Gown packaged with 2 Towels
- Overlapping Back
- Low Linting Fabric
- Colour-Coded Neck Binding
- Reinforced Chest and Sleeves
- Adjustable Hook & Loop Neckline
- AAMI Level 4 Gown
- Reinforced Chest

MEDIKOOOL SURGICAL EXTRA PROTECTION GOWNS, STERILE

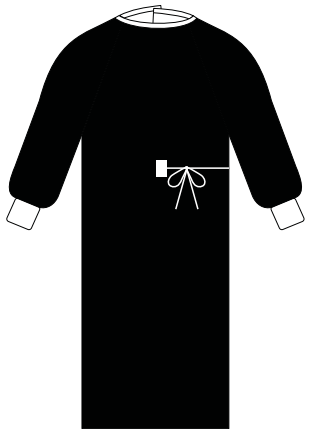

Code	Description	Packaging
1091	Medikool Protection Surgical Gowns Medium	12
1092	Medikool Protection Surgical Gowns Large	12
1093	Medikool Protection Surgical Gowns X-Large	12
1094	Medikool Protection Surgical Gowns X-Large, X-Long	10
1095	Medikool Protection Surgical Gowns XX-Large	10

- Breathable Impervious Fabric
- Adjustable Hook and Loop Neckline
- Sterile Gown packaged with 2 Towels
- Low Linting Fabric
- Generous Cut
- Color Coded Neck Binding
- Book Fold
- AAMI Level 4 Gown



PROTECTIVE GOWNS / PROTECTIVE WEARS

PROTO - LAMINATED GOWN, STERILE

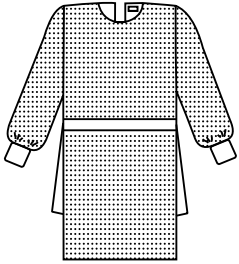

Code	Description	Packaging
1201	Proto Laminated Gown, Large, Sterile	30
1202	Proto Laminated Gown, X - Large, Sterile	30

- Moderate to high level of fluid protection
- Bi laminated poly coated fabric as per the standard ASTM
- F1670 Synthetic Blood Penetration Resistance
- Knit or elastic cuff options provide a secure fit under gloves
- Velcro / Neck tie closure for individual size adjustment

ISOLATION GOWN WITH KNITTED CUFF, STERILE

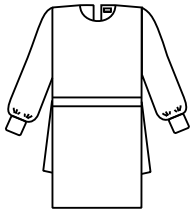

Code	Description	Packaging
1221	Isolation Gown With Knitted Cuff Large, Sterile	35

- Low level of fluid protection
- Full coverage cover gown
- Neck tie closure for individual size adjustment
- Non Woven Fabric
- Knit provide a secure fit under gloves

VISITOR ISOLATION GOWN, NON-STERILE

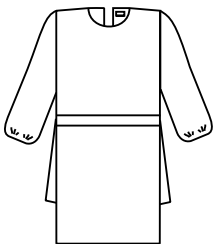

Code	Description	Packaging
1241	Visitor Isolation Gown Large, Non Sterile	42

- Low level of fluid protection
- Full coverage cover gown
- Neck tie closure for individual size adjustment
- Non Woven Fabric
- Elastic cuffs provide a secure fit under gloves

PATIENT GOWN, NON-STERILE

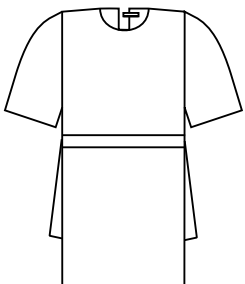

Code	Description	Packaging
1251	Patient Gown Large, Non Sterile	34

- Comfortable Non Woven Fabric
- Neck tie closure for individual size adjustment



PROTECTIVE GOWNS / PROTECTIVE WEARS

SCRUB SHIRT, NON-STERILE

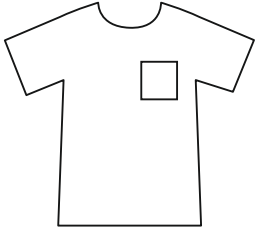

Code	Description	Packaging
1401	Scrub Shirt Medium, Non Sterile	60
1402	Scrub Shirt Large, Non Sterile	60
1403	Scrub Shirt X-Large, Non Sterile	60

- Made of heavy durable, dark blue SMS fabric
- V-Neck opening and one pocket

SCRUB PANT, NON-STERILE

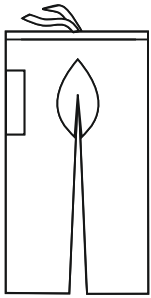

Code	Description	Packaging
1421	Scrub Pant Medium, Non Sterile	45
1422	Scrub Pant Large, Non Sterile	45
1423	Scrub Pant X-Large, Non Sterile	45

- Made of heavy durable, dark blue SMS fabric
- Pockets
- Pants have drawstring or elastic waist

LAB COAT, NON-STERILE

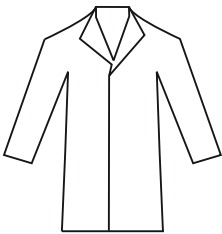

Code	Description	Packaging
1451	Lab Coat Large, Non Sterile	30
1452	Lab Coat X-Large, Non Sterile	30
1453	Lab Coat XX-Large, Non Sterile	30

COVERALL, NON-STERILE

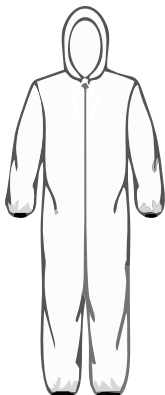

Code	Description	Packaging
1320	Coverall Dlx with Hood Large, Non-Sterile	45
1321	Coverall Dlx with Hood Large, Non-Sterile	50
1325	Coverall with Hood Large, Non-Sterile	40



PROTECTIVE KITS, STERILE

PROTEC KIT, STERILE

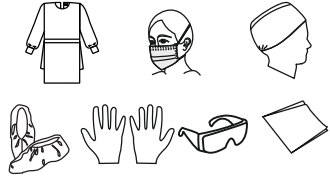

Code	Description	Packaging
1501	Protec Kit I	14

- 1 Isolation Gown 'L'
- 2 Shoe Covers
- 1 Face Mask Tie
- 1 Goggles
- 1 Pair Latex Gloves
- 1 Surgical Cap
- 1 Disposable Bag

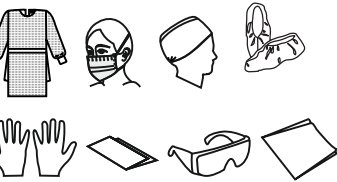

Code	Description	Packaging
1503	Protec Kit II	14

- 1 Proto Gown 'L'
- 2 Shoe Covers
- 1 Goggles
- 1 Face Mask Tie
- 1 Latex Gloves
- 1 Disposable Bag
- 1 Surgical Cap
- 1 Drape Sheet

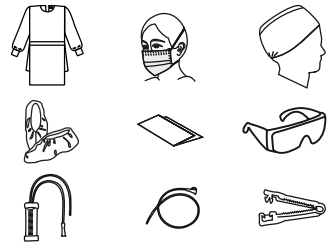

Code	Description	Packaging
1505	Protec Kit VI	8

- 3 Isolation Gown
- 6 Shoe Cover
- 1 Mucus Extractor
- 1 Face Mask Tie
- 3 Drape Sheet
- 1 Feeding Tube
- 1 Surgical Cap
- 3 Goggles
- 1 Umbilical Cord Clamp

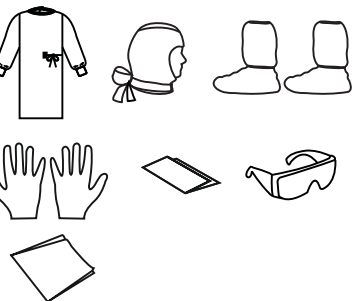

Code	Description	Packaging
1513	Protec Kit X	8

- 1 Medipro Surgical Gown 'L'
- 2 Shoe Leggings
- 1 Goggles
- 1 Face Mask Tie
- 1 Latex Gloves
- 1 Disposable Bag
- 1 Hood Cap
- 1 Drape Sheet
- 1 Surgical Mask Tie



PROTECTIVE KITS, STERILE

SURGICAL DRESSING KIT, STERILE

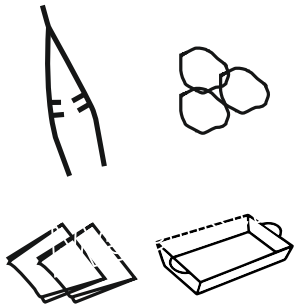

Code	Description	Packaging
6901	Opening Closing Kit	120
6902	Haemodialysis Starting & Closing Kit	120
6903	Minor Kit I	120
6904	Minor Kit II	120
6905	Major Kit I	120
6906	Major Kit II	120

SCRUB SUIT, NON STERILE

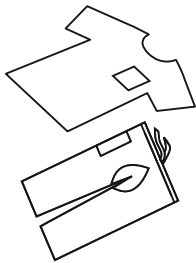

Code	Description	Packaging
1701	Scrub Suit Medium	20
1702	Scrub Suit Large	20
1703	Scrub Suit X-Large	20

- 1 Scrub Shirt
- 1 Scrub Pant

VISITOR KIT

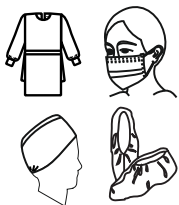

Code	Description	Packaging
1708	Visitor Kit	30

- 1 Visitor Gown
- 1 Face Mask Tie
- 1 Surgical Cap
- 2 Shoe Covers



PROTECTIVE KITS, NON STERILE

PPE KIT, NON STERILE

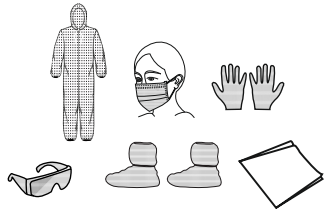

Code	Description	Packaging
1519	PPE Kit I	20

- 1 Coverall Bi Laminated w/hood 'L'
- 1 Surgical Mask / N95 / FPP2 Mask
- 1 Pair Surgical Gloves / Nitrile Gloves
- 1 Goggle
- 2 Shoe Cover Bilaminated
- 1 Disposable Bag

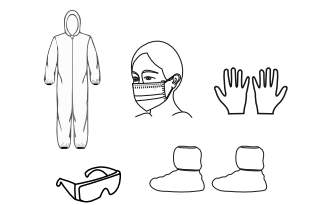

Code	Description	Packaging
1520	PPE Kit II	20

- 1 Coverall Impervious w/hood 'L'
- 1 Surgical Mask / N95 / FPP2 Mask
- 1 pair surgical gloves / Nitrile gloves
- 1 Goggle
- 2 Shoe Cover Impervious

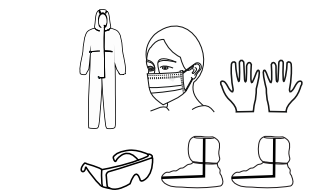

Code	Description	Packaging
1522	PPE Kit III	20

- 1 Coverall w/hood & Seam Sealed Tape 'L'
- 1 Surgical Mask / N95 / FPP2 Mask
- 1 pair surgical gloves / Nitrile gloves
- 1 Goggle
- 2 Shoe Cover Seam Sealed Tape



PROTECTIVE APPARELS & HYGIENE PRODUCTS



Mediklin

 Healthcare

You Specify We Create





PROTECTIVE APPARELS

FACE PROTECTION

SURGICAL FACE MASK TIE



Code	Description	Packaging
6001	Face Mask Tie Blue 'Mediklin' - 2 Layer	1000
6002	Face Mask Tie Blue 'Mediklin' Ind. - 2 Layer	1000
6003	Face Mask Tie Blue 'Supra' - 2 Layer	3000
6004	Face Mask Tie Blue 'Supra' Ind. - 2 Layer	3000
6005	Face Mask Tie Blue Bulk - 2 Layer	6000
6021	Face Mask Tie Green 'Mediklin' - 2 Layer	1000
6022	Face Mask Tie Green 'Mediklin' Ind. - 2 Layer	1000
6023	Face Mask Tie Green 'Supra' - 2 Layer	3000
6024	Face Mask Tie Green 'Supra' Ind. - 2 Layer	3000
6025	Face Mask Tie Green Bulk - 2 Layer	6000
6041	Face Mask Tie Blue 'Mediklin' - 3 Layer	1000
6042	Face Mask Tie Blue 'Mediklin' Ind. - 3 Layer	1000

- Fluid Resistance
- Non Allergic Fabric
- Aluminum Nose Clip

STANDARD FACE MASK LOOP



Code	Description	Packaging
6063	Face Mask Loop Blue 'Supra' - 2 Layer	6000
6064	Face Mask Loop Blue 'Supra' Ind. - 2 Layer	3000
6065	Face Mask Loop Blue Bulk - 2 Layer	7500
6073	Face Mask Loop Green 'Supra' - 2 Layer	6000
6074	Face Mask Loop Green 'Supra' Ind. - 2 Layer	3000
6075	Face Mask Loop Green Bulk - 2 Layer	7500
6081	Face Mask Loop Blue 'Mediklin' - 3 Layer	2000
6082	Face Mask Loop Blue 'Mediklin' Ind. - 3 Layer	1000

- Fluid Resistance
- Aluminum Nose Clip
- Non Allergic Fabric
- Non Allergic Fabric in Bouffant cap, crimp, surgeon
- Soft, Stretchy Ear Loop



PROTECTIVE APPARELS

HEADWEAR

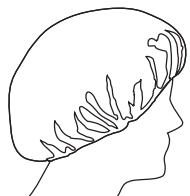

BOUFFANT CAP

Code	Description	Packaging
6371	Bouffant Cap Blue 'Supra'	2250
6372	Bouffant Cap Green 'Supra'	2250

- Fluid-resistant
- Soft, Non-binding, Latex-free Elastic Band

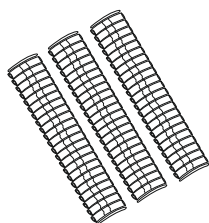

CRIMP CAP

Code	Description	Packaging
6376	Crimp Cap Blue	2000
6381	Crimp Cap Green	2000

- Fluid-resistant
- Soft, Non-binding, Latex-free Elastic Band

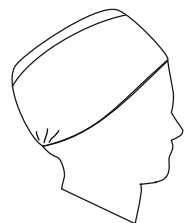

SURGEON CAP

Code	Description	Packaging
6301	Surgical Cap Blue 'Mediklin'	1000
6302	Surgical Cap Blue 'Mediklin' Ind.	1000
6303	Surgical Cap Blue 'Supra'	1000
6304	Surgical Cap Blue 'Supra' Ind.	1000
6316	Surgical Cap Green 'Mediklin'	1000
6317	Surgical Cap Green 'Mediklin' Ind.	1000
6318	Surgical Cap Green 'Supra'	1000
6319	Surgical Cap Green 'Supra' Ind.	1000
6331	Surgical Cap Deluxe Blue 'Supra'	1000
6332	Surgical Cap Deluxe Blue 'Supra' Ind.	1000
6351	Surgical Cap Deluxe Green 'Supra'	1000
6352	Surgical Cap Deluxe Green 'Supra' Ind.	1000

- Fluid-resistant
- Soft, Non-binding, Latex-free Elastic Band



PROTECTIVE APPARELS

HEADWEAR

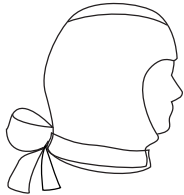

HOOD

Code	Description	Packaging
6386	Surgical Hood Cap	500

- Fluid-resistant
- Soft, Breathable Fabric
- Comfortable For Long Surgeries

FOOTWEAR

SHOE COVER

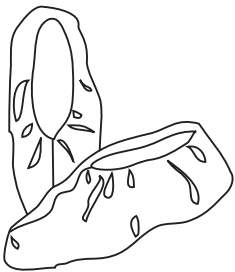

Code	Description	Packaging
6501	Shoe Cover PE 'Mediklin'	1000
6502	Shoe Cover PE Bulk	6000
6511	Shoe Cover NWF 'Mediklin'	1000
6512	Shoe Cover NWF Bulk	4000

- Fluid-resistant
- Fully Elasticized

SHOE LEGGING

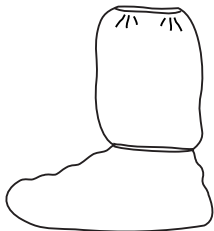

Code	Description	Packaging
6521	Shoe Legging PE	1500
6531	Shoe Legging NWF 'Mediklin'	600

- Fluid-resistant
- Knee High With Elastic Top And Ankle

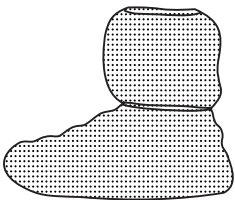

Code	Description	Packaging
6551	Protec Boot Guard	400

- Fluid-resistant
- Ankle High With Elastic Top And Ankle
- Non-skid tread

APRON, STERILE

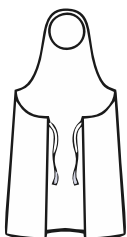

Code	Description	Packaging
6601	Large	1200
6602	X-Large	900

- Die-cut Head Openings and Extra-long Ties
- Light but Strong Polyethylene



PROTECTIVE APPARELS

APRON, STERILE

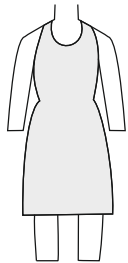

HALF GOWN, STERILE

Code	Description	Packaging
6621	Large	600
6622	Large	600

- Die-cut head openings and extra-long ties
- Light but strong polyethylene

COUCH ROLL

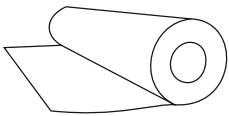

Code	Description	Packaging
6781	Couch Roll 60 x 7500cms	12

SHEETS & PILLOW COVER

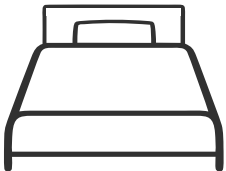
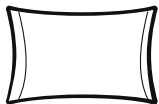

Code	Description	Packaging
6701	Bed Sheet Blue	130
6702	Half Sheet White	200
6721	Pillow Cover Blue	600
6731	Bed Sheet & Pillow Cover Blue	100
6751	PE Sheet 100 x 150cms	600
6752	PE Sheet 140 x 150cms	480
6771	Plain Sheet 120 x 150cms	390
6772	Plain Sheet Large 120 x 210cms	300
6773	Plain Towel 66 x 120cms	600
6774	Dental Liner	1000



HYGIENE PRODUCTS

ADULT DIAPER

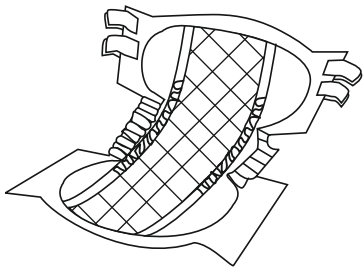

Code	Description	Packaging
6820	Comfy Adult Diaper 'XL' - 10's Pack	100
6815	Comfy Adult Diaper 'L' - 10's Pack	100
6811	Comfy Adult Diaper 'M' - 10's Pack	100

- Sturdy Tape Tabs
- Breathable Top Sheet
- Super-absorbent Polymer, Blue Dryness Strip
- Diamond And Linear Embossing

UNDERPAD

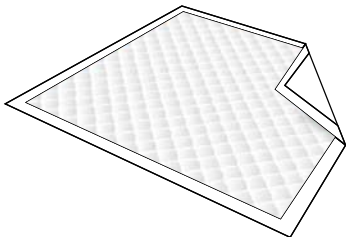

Code	Description	Packaging
6801	Cozy Underpad 60 x 90cms - 10's Pack	200

- Super absorbent soft core
- Moisture vapor permeable film





Mediklin

Healthcare

 022 43471890 | 98200 21460

 www.mediklin.com  info@mediklin.com

 E-37/42, Span Industrial Estate, Near Dadra Check Post,
Dadra - 396 193, Dadra & Nagar Haveli (U.T.), India